



ASPIRADORA ROBOT LASER

Manual de conexión e Instrucciones de uso

(Por favor leer las instrucciones cuidadosamente antes de usar,
y mantener en buenas condiciones para futuras referencias)



www.greenwind.online

MANUAL DE CONEXIÓN A LA APP



Disponible para:

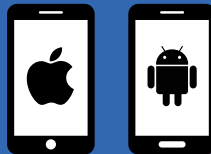

■ 1 |

Utilice la cámara de su celular o escaner de código QR para descargar la **APP Greenwind e-home**.

Otra opción es buscar en APPStore en iPhone o Playstore en Android y descargar desde ahí.

*Por favor chequear que su smartphone está correctamente conectado a WiFi.



■ 2 |

Lea la “Política de privacidad” y seleccione “De acuerdo”

Si no tiene una cuenta existente, seleccione “**Crear cuenta nueva**”.

Para el inicio de sesión por primera vez, elija de la lista el país de residencia.

Ingrese su dirección de mail, tilde la casilla “Estoy de acuerdo con la política...”, y seleccione “Enviar código”

(Se le enviará un código al mail registrado)

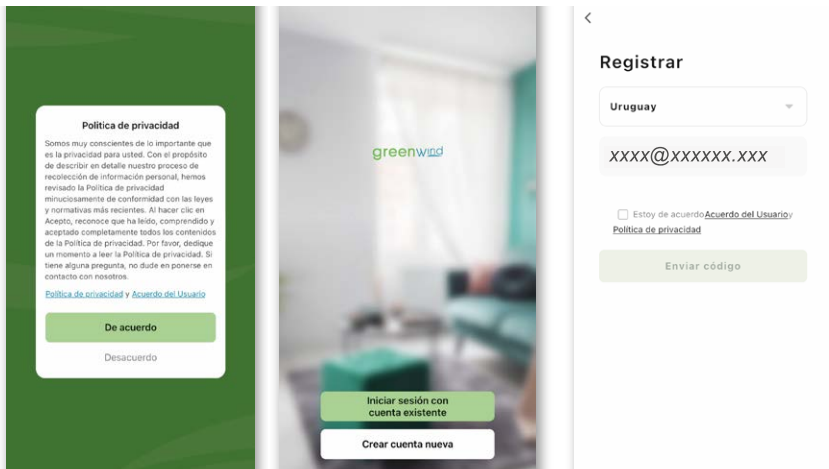

■ 3 |

Ingrese el código de verificación recibido en su mail
Establezca su contraseña de 6-20 caracteres, incluyendo
letras y números
Seleccione "Finalizado"

Introducir código de verificación

El código de verificación se ha enviado a su correo: [xxxx@xxxxxxxx.xxx](#) [Enviar de nuevo](#)
[¿No recibió un código?](#)

1	2	3
4	5	6
7	8	9
0		

Establecer la contraseña

Password

Finalizado

■ 4 | Iniciar sesión

Si ya tiene una cuenta creada, seleccione:
"Iniciar sesión con cuenta existente"
Elija de la lista el país de residencia
Ingrese el mail registrado y la contraseña establecida
Tilde la casilla "Estoy de acuerdo..."
Seleccione "Iniciar sesión"

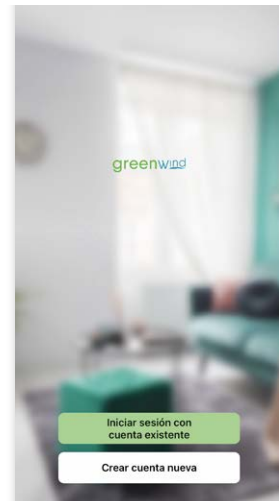

Iniciar sesión

Uruguay

XXXX@XXXXXX.XXX

Estoy de acuerdo [Acuerdo del Usuario](#) y [Política de privacidad](#)

Iniciar sesión



[He olvidado la contraseña](#)

5 | Agregar Dispositivo

5.1

Encienda la aspiradora con el botón de ON en el panel superior. Espere a que la voz indique: **“Hello Master, the machine is ready”**, presione los 2 botones del panel la misma vez por 3 segundos, hasta que escuche un **beep (reseteo de WiFi)**.

5.2

Inicie sesión en APP  En el sector “Home” presione el símbolo de  en la esquina superior derecha, o en el botón central **“Add Device”** Luego seleccione la figura de la aspiradora

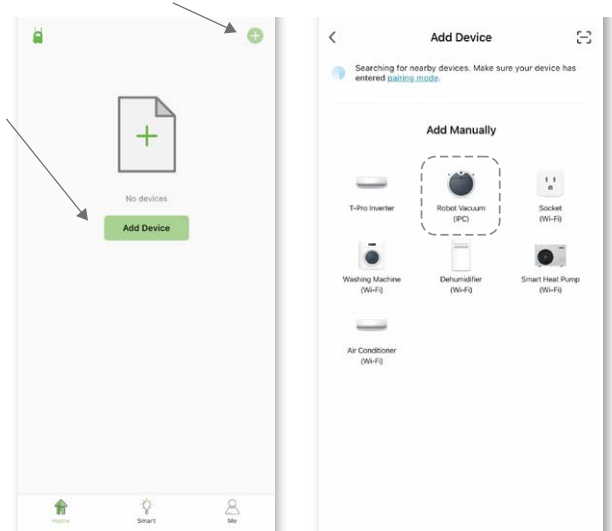

5.3

Siga las instrucciones que aparecen en la siguiente pantalla. Presione  en la esquina superior derecha y seleccione: **“Modo EZ”**. Tilde el círculo de confirmación. “Verifique que el indicador parpadee rápidamente” y seleccione “Siguiente”.

(Ingrese la contraseña de la red de WiFi, que debe ser la misma a la que está conectado su smartphone, luego presione “Siguiente”)

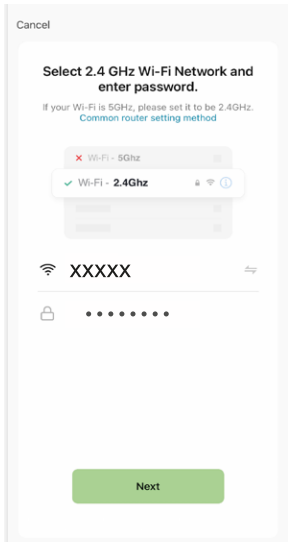

Siga el paso a paso indicado en su pantalla.

Durante el proceso podrá escuchar: **“The appliance is starting to bind the user information”**

Quando esté pronta: **“Network is connected. What can I do for you Master?”**

MANUAL DE USO

Cuando se conecte correctamente se escuchará:

**“Network is connected.
What can I do for you Master?”**

**Una vez conectado, se ingresa a la interfase de control
de la aspiradora.**

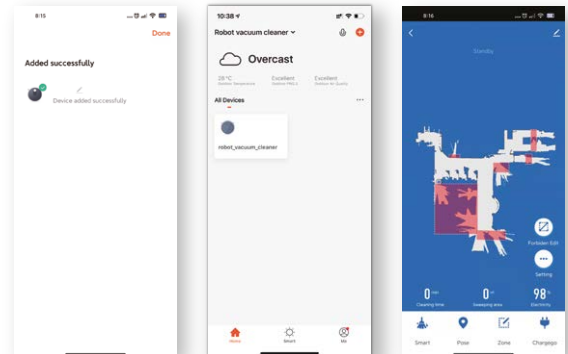

II.APP Functions Introduction

1.Click "Smart" to start auto-cleaning (default setting), click again to pause it. Click "Chargego" for recharging.

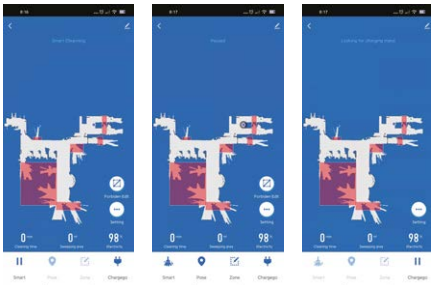

2. Click "Setting", select "Suction" to adjust suction level: Strong, Normal,Gentle or Auto. Select "Water quantity" to adjust water discharge level: High, Middle or Low.

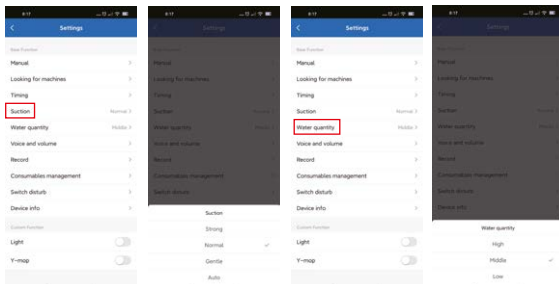

3.Click "Pose" to stop current task. Select the position on the map you want to clean, click "Go Here" to start point cleaning, click "Back" to stop it.

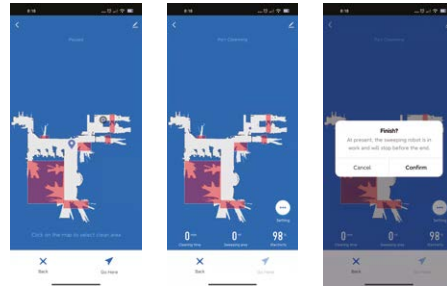

4.Select "Zone", click "Sweep area",drag the area on the map you want to clean, click "Go Here" to start zone cleaning,click "Back" to stop it.

Click "Forbidden Edit" and then "Add area" to create the area you don't want to clean, save it.

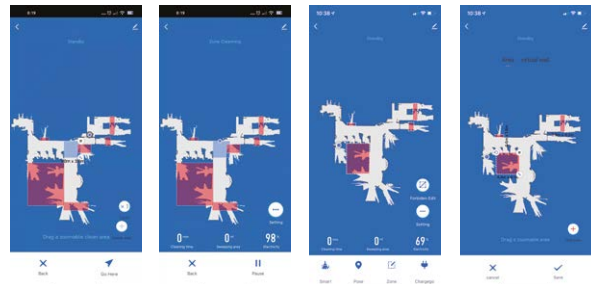

5. Under mopping mode, click "Smart" to start auto-mopping, back for recharging after mopping is finished.

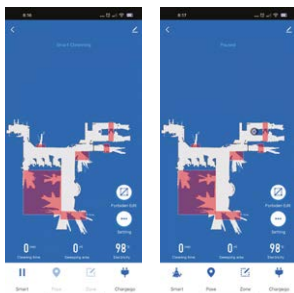

2) Click "Manual" to manually control robot vacuum movement.
3) Click "Looking for machines" to find where the robot vacuum is.

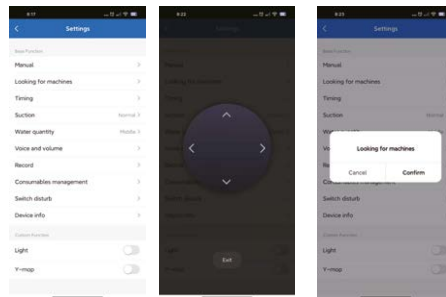

6. Click "Setting" in the lower right corner.

1) Timing: Click "Add" to set scheduled cleaning time and date and Save the setting.

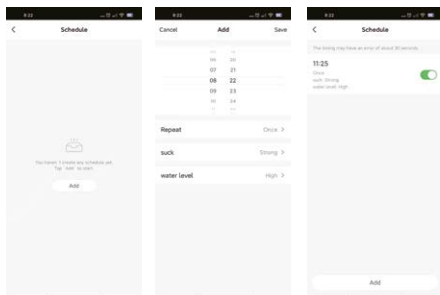

4) Click "Record" to check cleaning records.

5) Click "Voice and volume" to adjust voice volume and switch voice language.

6) Click "Switch Disturb" to open non-disturb function.

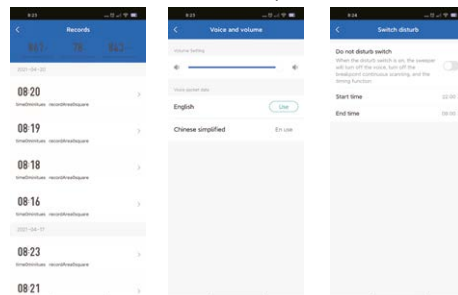

Instructions for use

01. The product is only for the cleaning of the floor in the home environment and do not use it outdoors (such as open balcony), non-ground (such as sofa, coffee table, etc.), commercial or industrial environment.
02. Do not use the product in a suspended environment (such as duplex floors, home tops, etc.) to avoid property damage and personal injury caused by falling of the device.
03. Do not use the product in an environment above 40 °C or below -10 °C.
04. Do not use the product in a ground environment with liquid or sticky materials.
05. Please clean up the debris or scattered objects and cables on the ground before use to avoid the machine being blocked or entangled during operation.
06. Please ensure that the items that are fragile, easy to fall, expensive or potentially dangerous are stored properly before use to avoid personal injury or property damage caused by the robot vacuum cleaner during operation.
07. The people with physical, mental or cognitive impairments, including children are not allowed to use or operate the product.
08. Please properly keep the product, charging stand and product accessories to prevent children from touching to avoid personal and property damage.
09. Do not allow children to use the robot vacuum cleaner as a toy. Keep the children and pets as far away as possible during its working and cleaning.
10. Do not place the hair, clothing, fingers, etc. of the human close to the suction port and operating parts of the product.
11. The products must not allowed to absorb any burning items such as cigarettes, matches, ash and other items that may cause fire.
12. The products must not allowed to absorb any items such as stones, waste paper, nails, broken glasses, etc. that may block the product.
13. Do not move the machine by the lidar cover as the handle to avoid damage of the lidar.
14. Please clean and maintain the machine and the charging stand during shutdown or power off.
15. Please clean the charging stand and the product with a dry soft towel and do not wipe any part of the product with any damp cloth, detergent or liquid.
16. During the initial use of the product, please always observe the work of the robot vacuum cleaner to help deal with some possible problems, such as the wound cables, the uneven area and the area that may make the robot vacuum cleaner suspending or stuck. And these areas can be set in the APP once they are found to prevent the robot vacuum cleaner from entering these areas the next time during work.
17. Please use the product strictly in accordance with the product instruction, and any loss or damage caused by improper use shall be borne by the user.

🔌 What inside box

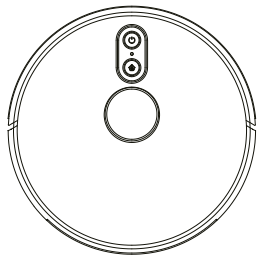

Machine

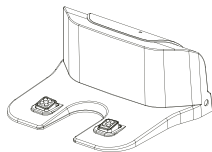

Charging stand



Extra Mop

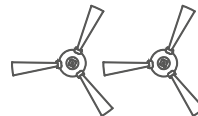

Side brush

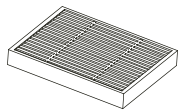

High efficiency filter

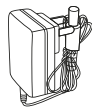

Power adapter

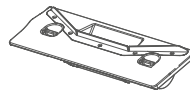

Single suction
port component



Cleaning brush

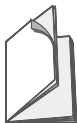

Instruction

🔌 Machine Introduction

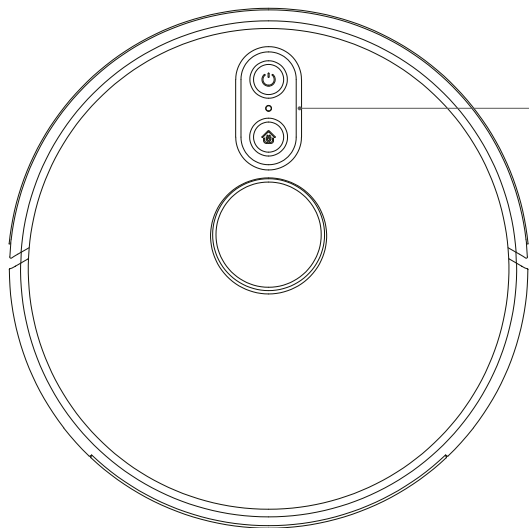

Power key:
Short press: Sweep/pause
Long press: On/off the machine

WiFi indication light:
Slow flash: Waiting for connection
Normally on: WiFi is connected
Quick flash: WiFi connection failed

Recharge key:
Short press: recharge / pause
Long press: Timing cleaning

LED Indication

Blue LED: Charging

Red LED: Fault

Anti-dropping sensor

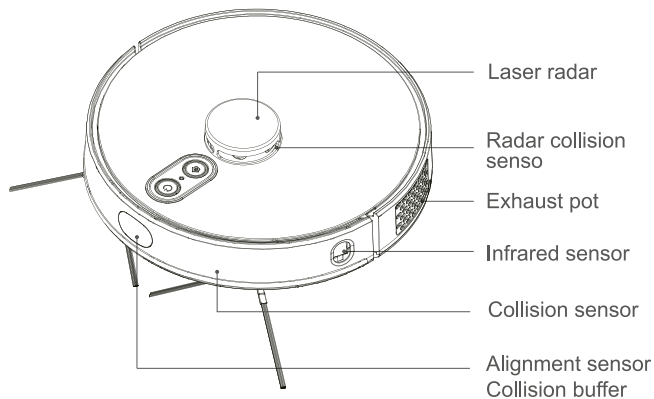
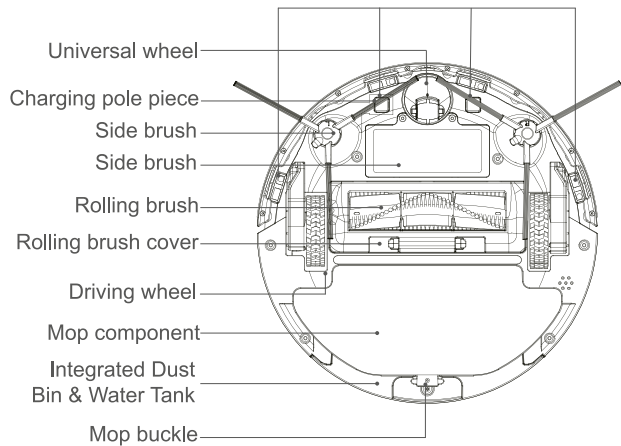

⏻ Product Operation

1 Indoor cleaning

Please clean up small objects, fragile articles, cables, curtain ropes, etc. scattered on the ground before use to prevent entanglement or damage of the property.

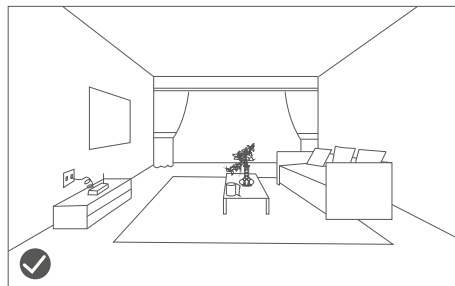
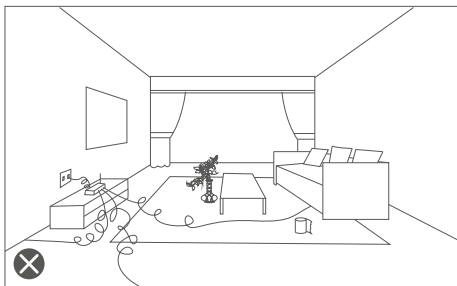

The users with a duplex structure such as stairs etc. in their homes shall specially note that it is strictly forbidden to use the product in the fenceless suspending environment, which is higher than that of the family activities.

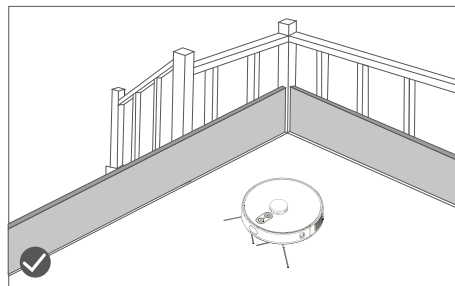
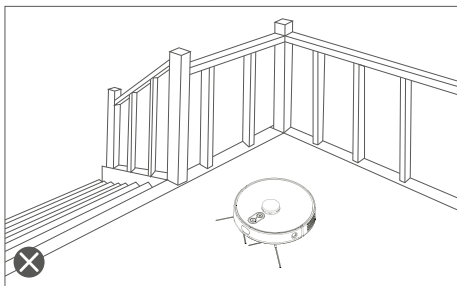

2 Side Brush Installation

Align the side brush with its bearing on the machine and press firmly to install the left and right brushes.

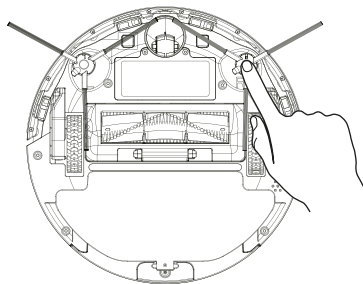

3 Water Tank Installation

Open the rubber cover on the water tank, fill in water and then install back.

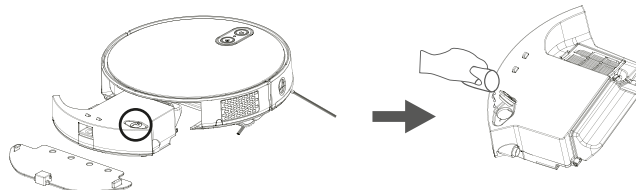

4 Power On

Press power button for 3 seconds and voice prompts powered on.

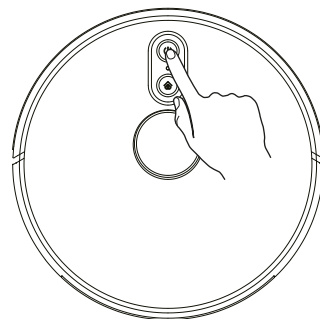

5 Recharging

Please make sure that no obstacles in the space of 1 m on both sides and 2m ahead of the charging stand. Charge the robot vacuum cleaner on the charging stand,

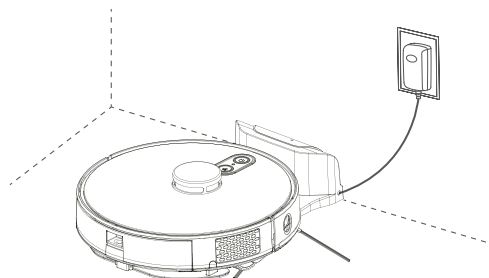
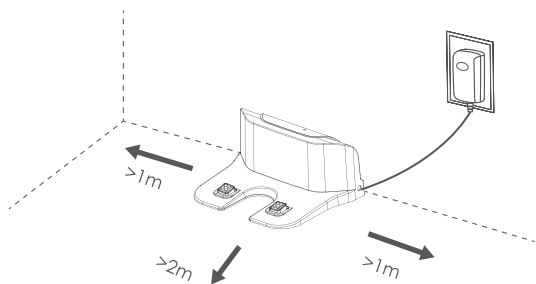

Product maintenance

1 Dust Bin Cleaning

Pull out the dust bin, open the buckle and clean the dust.

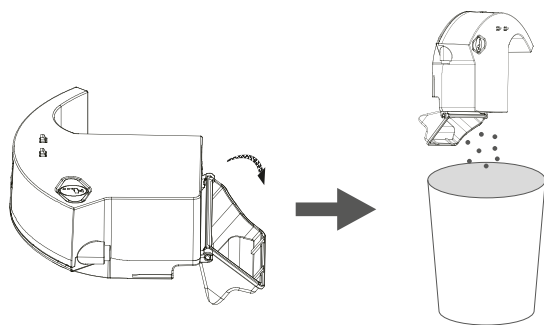

2 HEPA Filter Cleaning

Open the buckle of HEPA bracket, take out HEPA and clean it.

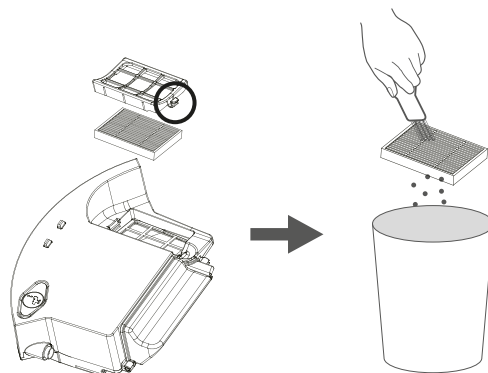

3 Cleaning of rolling brush

Turn the machine and press the buckle on the rolling brush cover from both ends to remove the rolling brush. Clean the windings on the rolling brush with the matching cleaning brush. After cleaning, install the rolling brush and fasten the cover.

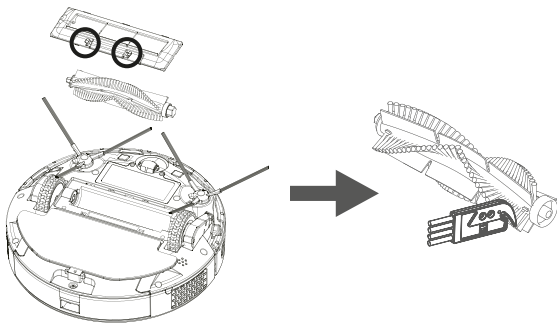

4 Side Brush Cleaning

lift the left and right brushes up and pull them out, Clean the windings on the left and right brushes and their bearings.

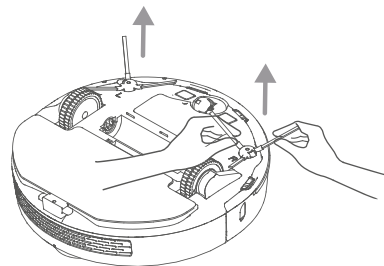

5 Replace the battery

1. When replacing the battery, cut off the power and turn off the unit.
2. Remove the screw on the battery cover, pull out battery terminal and take out the lithium battery from the cabinet.
3. Connect the terminal of the new battery, put the battery into the cabinet and put battery cover back with screw.

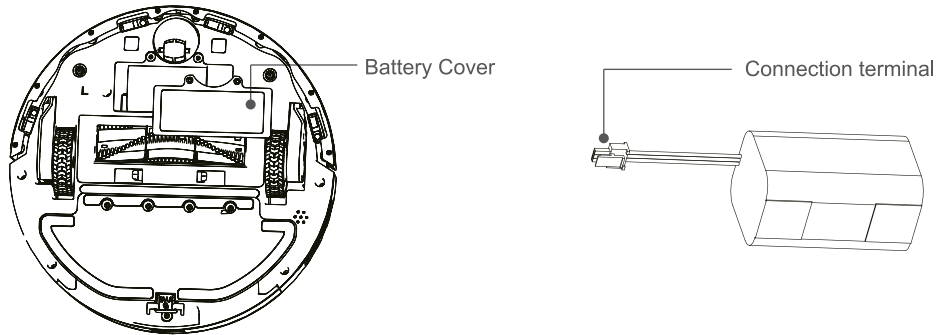

WARNING

Do not discard used batteries at will and please give the professional recycling agency for treatment.

Product parameters

Parameters of main machine

Dimensions	L315*W315*H92mm
Battery	Lithium battery,3200mAH
Host Weight	2.8±0.1KG
Connection Method	WiFi connection
Rated Voltage	14.4V
Rated Power	40W
Water Tank Capacity	200ml
Dust Box Capacity	300ml

Parameters of charging stand

Dimensions	L185*W140*H75mm
Rated input	100-240V 50/60Hz
Rated output	24.0V/1.0A
Rated power	50/60Hz

The name and content of hazardous substances in the product

Component	Hazardous substances					
	Lead/pb	Hg	Cd	Cr (VI)	PBB	PBDE
Plastic parts	○	○	○	○	○	○
Metal parts	×	○	○	○	○	○
Circuit board	×	○	○	○	○	○
Battery	×	○	○	○	○	○
Wire	○	○	○	○	○	○
Adapter	×	○	○	○	○	○

O indicates that the content of the hazardous substance in all homogeneous materials of the component is below the limit requirement specified in GB/T 26572.

X indicates that the content of the hazardous substance in at least one of the homogeneous materials of the component exceeds the limit requirement specified in GB/T26572.

Voice prompts and trouble-shooting

Sn.	Voice prompt	Cause	Trouble-shooting
1	The dust box is missing.	The cleaning is triggered during removing of the dust box.	Re-install the dust box or pause the cleaning task of the machine.
2	AH OH, the radar on the top seems to be covered.	The top radar is covered or be placed in an open area	Please check and remove foreign objects around the Lidar or move it to other place to restart.
3	I need to change a position to start to work.	The device is picked up	Move the machine to other place to restart cleaning.
4	Pls wipe the bottom falling protecting sensor, my master.	The anti-dropping sensor is blocked or placed high	Please check and clean the anti-dropping sensor and try again.
5	Pls wipe the crashing protecting sensor right ahead, my master.	Collision sensor abnormal	Please check and clean the anti-collision sensor and try again.
6	Pls wipe the wall sensor on the right side, my master.	Wall sensor is abnormal	Please check and clean the wall sensor and try again.
7	Pls wipe the radar cover on the top, my master.	The anti-collision sensor on radar cover is abnormal.	Please check and clean the foreign objects around the radar cover and try again.
8	AH OH, the crash barrier is stucked.	The bumper or anti-collision sensor is stuck.	Please check if the bumper or anti-collision sensor is stuck.
9	Pls clean the dust box, my master.	The dust box is full or the filter needs to be replaced.	Please clean the dust box or replace it with a new one.
10	AH OH, the main brush seems to be stucked. Pls help me.	The main brush is stuck or entangled.	Please check if the main brush is entangled and clean it.
11	AH OH, the main wheel seems to be stucked. Pls help me.	The main wheel is stuck or entangled.	Please check if the main wheel is entangled and clean it.

Sn.	Voice prompt	Cause	Trouble-shooting
12	AH OH, the side brush seems to be stucked. Pls help me.	The side brush is stuck or entangled.	Please check if the side brush is entangled and clean it.
13	I need battery charging, my master.	The main battery is too low to return to the charging stand	Please take the host back to the charging stand
14	Recharging failed. Pls put me back to the charging base, my master.	No charging stand is found, or the charging stand is not connected with the power supply.	Please check if the charging stand is energized and clean the obstacles around the charging stand.
15	Something is wrong, need to be power off and have a rest.	A failure that requires a shutdown occurs and it automatically shuts down	Please try to restart the machine.
16	Can't be power off when I'm on the charging base.	The shutdown operation is triggered during the charging of the machine on the charging stand.	The machine cannot be turned off while charging, please avoid it.
17	Positioning failed, can't do the cleaning.	Positioning failed, stop cleaning.	Please make sure the machine is connected to the network properly and try to relocate.
18	Positioning failed, can't find the way to charge.	Positioning failed, stop charging.	Please make sure the machine is connected to the network properly and try to relocate.

FAQ

Failure	Trouble-shooting
It cannot be turned on.	The battery is low, please charge it before use. The ambient temperature is over low or over high, please use it in the range of 0°C-40°C.
It cannot be charged.	The charging stand is not powered, please make sure the power is connected successfully. Poor contact of the charging electrode, please clean the charging stand electrode and the machine electrode.
The machine cannot be returned for charging.	Make sure there is enough space around the charging stand. And make sure that the recognition area on surface of the charging stand is free of dust and dirt.
The device cannot be found in the mobile.	Please reconnect WiFi and ensure that the network connection to the machine is successful.
The machine is offline.	Please ensure that the network connection of the machine is successful. And make sure the machine is always within the WiFi signal coverage.
The mobile and the device cannot be paired.	Make sure the machine and the charging stand are within the WiFi signal coverage and the signal is good. Please try resetting WiFi before pairing.
There is abnormal voice during cleaning.	Please check and clean the foreign matters on rolling brush, side brush, drive wheel and the universal wheel, and clean the machine chassis and anti-collision strip.
Cleaning is not effective.	Please check and clean the dust box and filter. Please replace the filter if it is blocked. Check and clean the rolling brush if it is entangled.
Timing cleaning doesn't work.	Timed cleaning cannot be triggered if the battery is low. Please confirm that the machine is connected to the network, otherwise, the timing cleaning task cannot be synchronized.
Whether it needs to be charged for 24 hours for the initial use.	The built-in high-performance lithium-ion battery has no memory effect, and it can be used after being fully charged and no need charging of 24 hours.
Whether the power of the charging stand is needed to be cut off after charging is completed.	In daily use, the standby power consumption is very low, so no need to power off and shut down, and maintaining the charging state is beneficial to the best performance of the battery. If it is not used for a long time, please cut off the power of the charging stand and shut it down for storage. It is recommended to charge once a month to avoid damage to the battery due to over-discharge.
Whether the laser emitted by the laser radar is harmful to the human.	The machine adopts advanced and safe laser radar, which meets the CLASS I laser standard and eye safety level.

Safety information

Battery and charging

01. Do not use any battery, charging stand or charger from third-party.
02. Please make sure that the voltage used is correct.
03. Do not disassemble, repair or modify the battery or the charging stand.
04. Do not place the charging stand and the main machine close to the heat source, such as heating radiators, induction cookers, ovens, etc.
05. Do not wipe anywhere of the product with a damp cloth or any liquid.
06. Do not discard used batteries at will and please give the professional recycling agency for treatment.
07. If the power cord is damaged or broken, please stop using it immediately, and contact us in time to select the proper channel to purchase the genuine power cord for replacement.
08. Please make sure that the main machine is turned off for transport and it is recommended to pack with the original box.
09. If the product is not used for a long time, please turn off the power after fully charged, turn off the main machine, store it in a cool dry place, and charge it at least every 3 months to avoid damage to the battery.

Laser safety information

Lidar of the product complies with the IEC 60825-1:2014 (Third Edition)

Applied standard

GB4706.1-2005, GB4706.7-2014, GB 4343.1-2018

FCC Caution.

This device complies with part 15 of the FCC Rules. Operation is subject to the following two conditions: (1) This device may not cause harmful interference, and (2) this device must accept any interference received, including interference that may cause undesired operation.

Any Changes or modifications not expressly approved by the party responsible for compliance could void the user's authority to operate the equipment.

greenwind

www.greenwind.online